

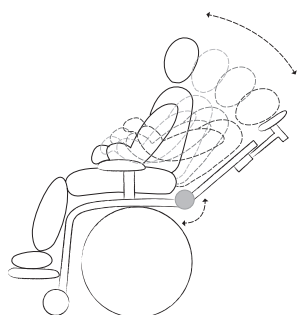

## 1 Adjustable back

Allows you to create three points of support for improved postural control, which reduces the risk of deformity while increasing the possibility to a higher level of activity. Here you are given the opportunity to modify and maintain an optimal position based on individual needs and status.



## 2 Flex-joint

A stable base of support is needed to assist the user in creating a functional seated position. A dynamic flexibility is also necessary in order to allow for freedom of movement, variation, and as a means of reducing the effects of extension spasticity. Zitzi Sharky is equipped with a flex-angle in the back to provide a dynamic seating, thus reducing both pressure and strain.



## 3 Integrated seat pocket

The anatomic form of the integrated seat pocket helps stabilize the pelvis in an upright position. This aids in facilitating a more functional postural control leading to greater level of activity, while simultaneously reducing shearing forces. The absence of an anatomic form in the seat for the pelvis leads to posterior tilt which has a negative effect on the spine and increases the effects of shear.

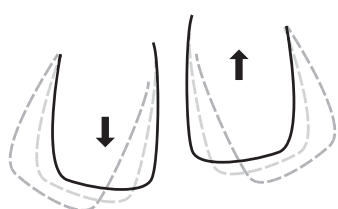

## 4 Adjustable thigh supports

The thighs supports can be adjusted exactly to suit seat depth and abduction, thus creating an optimal seated position which can “grow” with the user. It is even possible to create an open hip angle if needed.

**The picture is showing**  
Zitzi Sharky with different accessories on  
a Mika underframe

**Headrest**  
With three adjustable angles you are provided with an endless number of positions for an optimal fit

**Mounting bracket**  
To ensure the proper placement of positioning harnesses such as Sternum Support or the H-Strap

**Adjustable back**  
Easy to adapt to desired position, even when the user is seated. Offers three points of support.

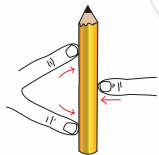

**Armrest**  
Adjustable in height, width, depth and angle

**Footrests**  
Several to choose from

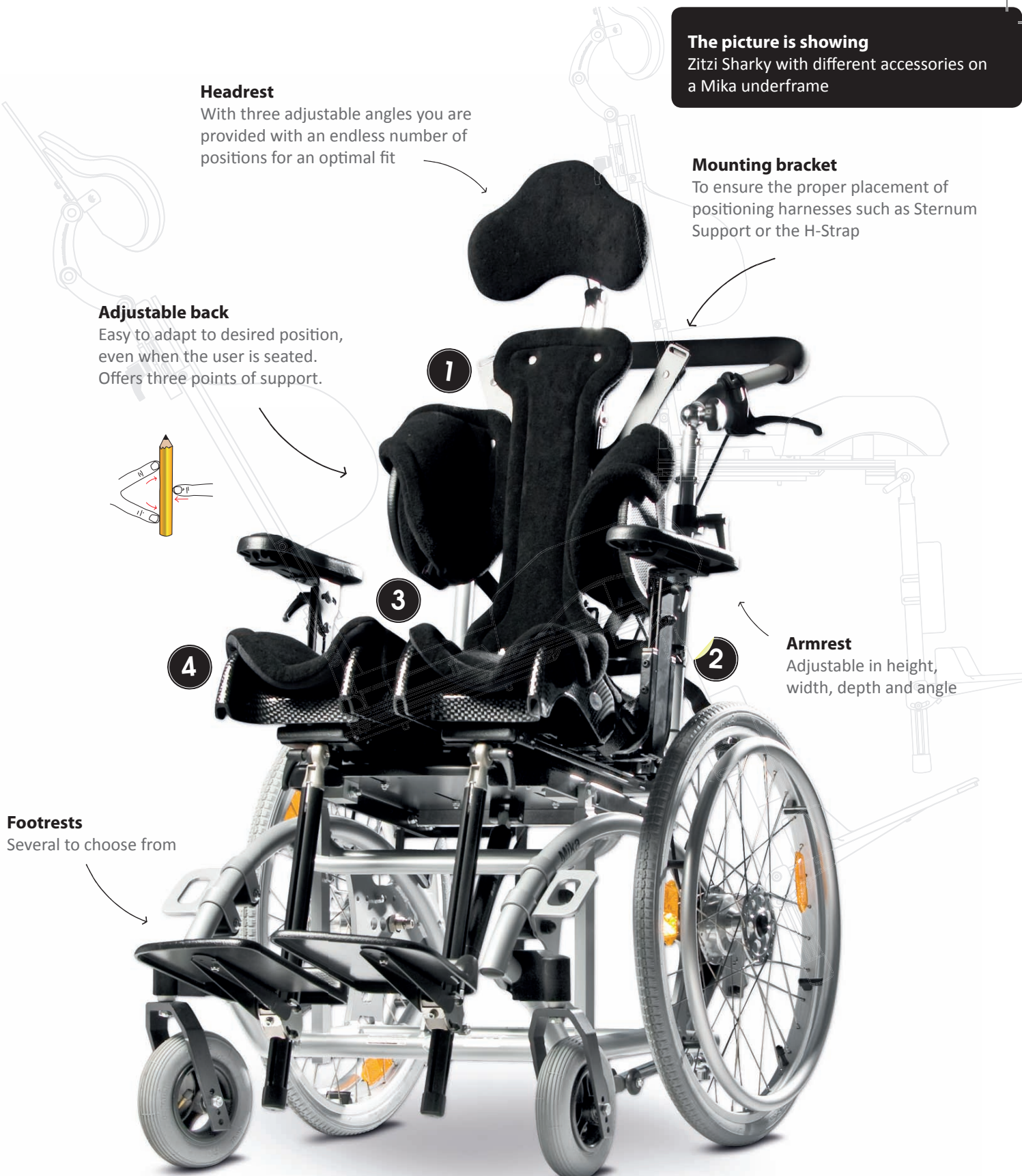

 SWEDISH QUALITY AND DESIGN



**Zitzi Sharky Quick facts**

The seating system for youths and adults with complex seating issues and advanced needs for adjustment possibilities. Thereby making it possible to achieve the best possible seated position within the same system.

<b>Sizes</b> .....	2 st	<b>Seat width</b> .....	40–50 cm
<b>Fabric, std</b> .....	Black	<b>Seat depth</b> .....	40–50 cm
<b>Axilla height</b> .....	31–50 cm	<b>Abduction</b> .....	10°
<b>Hip angle</b> .....	-20/+40°	<b>Flex-back</b> .....	Yes



Zitzi Sharky is the seating system with unsurpassable adjustment possibilities. Along with seamless adjustments in the seat and back, the back is equipped with a flexible angle which is helpful to those with extension spasticity. On top of the numerous

adaptation possibilities already available with the product, custom made modifications can also be requested. For advice, don't hesitate to contact any of our trained professionals who will be happy to assist you with ideas and solutions.



Sternum support

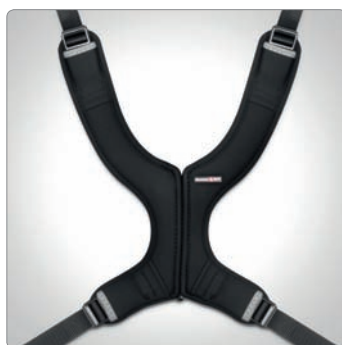

Sternum vest



H-Strap

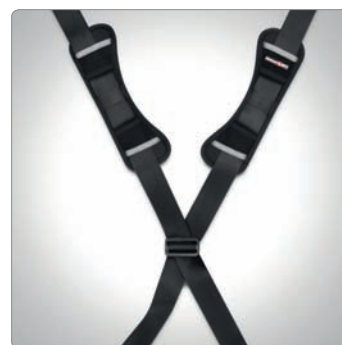

X-Strap



Hip belt



Adapter system



Adjustable back

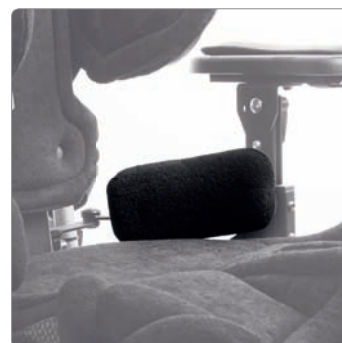

Pelvis support

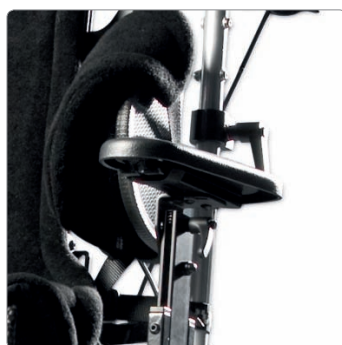

Armrest

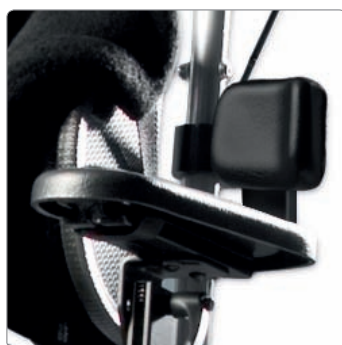

Upper arm support



Footrest



Divided turn-up footrest

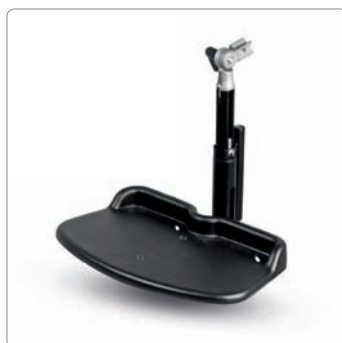

Flexible footrest



Adjustable footrest



Cushion (footrest)



Calf support (with cushion)



Driving bow



Table



Play bow



Sun cover



Sharky Standard



Pro Serie Single lower

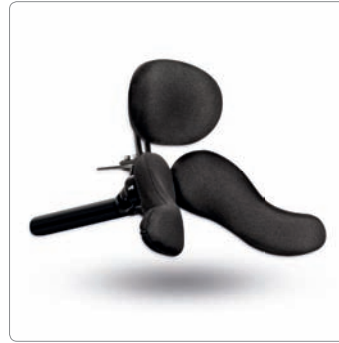

Pro Serie Adult



Pro Serie Mini



Pro Serie Plush



Pro Serie Junior



Bracelet



Ankle holder



**SWEDISH QUALITY AND DESIGN**

Seating system	Size	Fit underframe
Zitzi Sharky	1	Seabass Pro 2, Mika 2, Flipper, Flipper PRO 3, Flizzy 2
Zitzi Sharky	2	Seabass Pro 3, Mika 3, Flipper, Flipper PRO 3, Flizzy 3



Crash tested and approved according to ISO 7176-19 and ISO 10542



SWEDISH QUALITY AND DESIGN



## TECHNICAL DATA ZITZI SHARKY

Zitzi Sharky	Size 1	Size 2
User length, approx.:	125-160 cm	150-185 cm
Seat width:	> 40 cm	> 50 cm
Seat depth:	40-45 cm	45-50 cm
Axilla height:	31-47 cm	31-50 cm
Axilla to the top of the back:	16 cm	18 cm
Abduction:	10°	10°
Hip angle:	-20° to +40°	-20° to +40°

### ARMREST

A	B	C
Size 1 240 mm	Size 1 230-350 mm	Size 1 105 mm
Size 2 330 mm	Size 2 230-400 mm	Size 2 115 mm

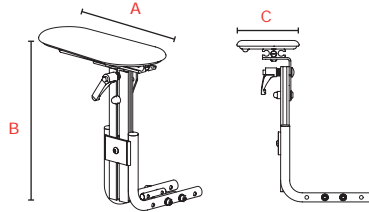

### PELVIS SUPPORT

A x B
Size 1 - 170 x 80 mm
Size 2 - 180 x 90 mm

(Same brackets, different mounting plates)

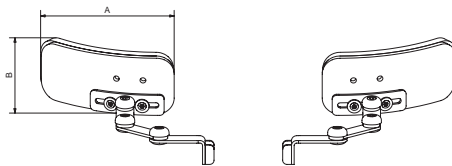

### SEATING PART

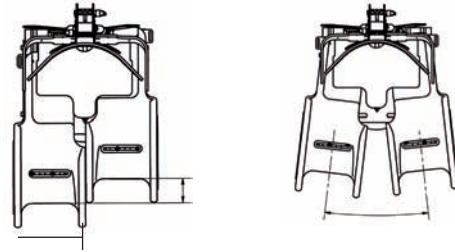

Seat depth:
Size 1 400-450 mm
Size 2 450-500 mm

Leg width:
Size 1 140 mm
Size 2 170 mm

Leg length difference:
Size 1 50 mm
Size 2 50 mm

Abduction:
Size 1 10°
Size 2 10°

### FOOTREST

The foot plates are the same size. The difference is the length of the footrest profile. See information below.

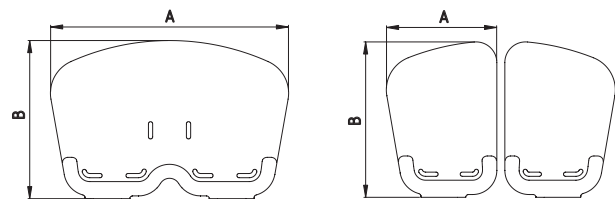

Foot plates	A x B	Foot plates	A x B
Footrest size 1	380 x 260 mm	Divided size 1	260 x 195 mm
Footrest size 2	380 x 260 mm	Divided size 2	260 x 195 mm

Footrest profile	Length
Profile size 1	400 mm
Profile size 2	450 mm

### HEADREST

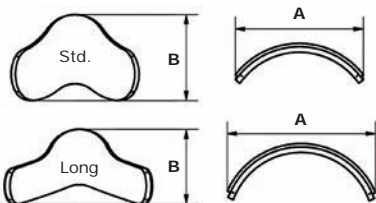
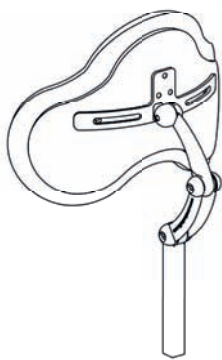

	A	B
Headrest size 1	220 x 150 mm	
Headrest size 1 long	280 x 160 mm	
Headrest size 2	240 x 190 mm	
Headrest size 2 long	280 x 210 mm	

### FIRM BACK

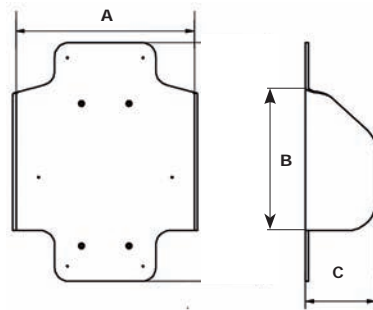

	A	B	C
Back size 0	240	260	120 mm
Back size 1	260	260	140 mm
Back size 2	290	280	180 mm
Back size 3	330	280	200 mm

### ADJUSTABLE BACK

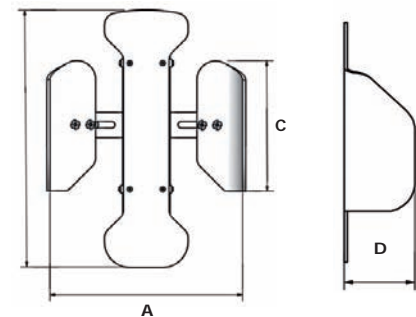

	A	C x D
Back size 1	220 - 290 mm	200 x 130 mm
Back size 2	220 - 320 mm	250 x 180 mm

All measurement are taken with cushions. Wedges will follow as standard and reduces the width of the back 3 cm.

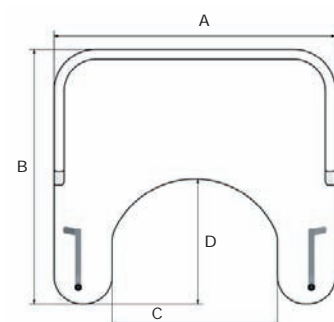

### TABLE

	A x B	C x D
Size 1	650 x 505 mm	390 x 190 mm
Size 2	710 x 650 mm	430 x 320 mm