

<b>Product</b>	Nursing bench 1000, electrically height adjustable
<b>Item number</b>	R8403000 VVS:777544380 NRF:7501955 EAN:5708590293271 HMI: 88221 NBS:N13:40,375
<b>Colour</b>	White
<b>Product description</b>	Nursing bench 1000, powered, height adjustable 400 mm; from 480 mm - 880 mm, with wired hand control Foldable. Incl. safety rail. Outer measurements 765 mm x 1800 mm Excl. fixing kit. See Technical datasheet (pdf) for information on fixings suitable for various wall types.
<b>Adjustability</b>	Height adjustable
<b>Adjustment height</b>	400 mm
<b>Maximum load</b>	Maximum load: 150 kg. When the bench is loaded with 150 kg, each mounting bolt supports 20 kg <i>This product has been tested statically with a load of 375 kg as the IEC 60601-standard requires testing with safety factor 2.5.</i>
<b>Speed without load</b>	Speed up mm: 15 mm/s Speed down mm: 20 mm/s
<b>Noise level</b>	48 dB
<b>Materials</b>	The bench is made from practical and durable PVC canvas which is phthalate free. The frame is powder-coated steel. Material: Steel, PVC.
<b>Ergonomy</b>	Pressalit Care offers a range of high quality, fixed or power adjusted nursing benches designed to provide a stable platform suitable for changing adults and children in a variety of settings: schools, day care centres, institutions, hospitals and private homes. Carers can easily set the height of the bench, enabling them to obtain the correct working position. This ensures safe showering and changing for the user as well as minimizing the risk of back injury for the carer.
<b>Features</b>	Electric with wired hand control – the red buttons clearly indicate “Up” and “Down”. The wired hand control comes with a holder for fitting to the wall. The integrated gas cylinders enable the bench to be folded out of the way when not in use to maximise floor space in front of the unit. Splash curtain (optional) for the nursing bench protects the carer against splashing.

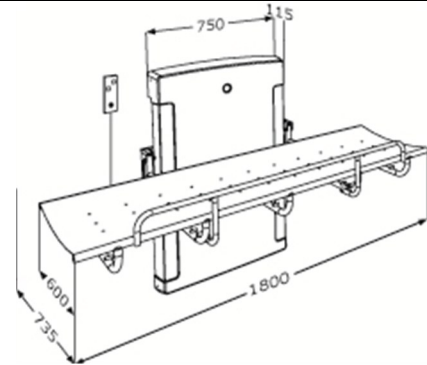



<b>Product</b>	Nursing bench 1000, electrically height adjustable
<b>Mains connection (V)</b>	230
<b>Actuator (motor)</b>	LA31 Careline, (Linak), 4000 N, IPX6
<b>Control box</b>	CB9 Careline, (Linak), IPX6
<b>Wired remote control</b>	HB3 (Linak), IP66
<b>Power usage</b>	Power consumption by maximum load: 70 W Power consumption by standby: 2 W
<b>Warranty</b>	<p>Pressalit Care makes a commitment to remedy material and manufacturing defects for a period of three years from the invoicing date. NOTICE If the product is installed in an atmosphere heavy in salt or chloride, the warranty of the nursing bench will be reduced from the normal 3 years to 1 year. Salt and chloride have a corrosive effect on the products components and will cause a decrease in the life expectancy of the product. The damaging effects can, however, be reduced if the product is showered with tap water on a daily basis.</p>
<b>Cleaning</b>	<p>Nursing benches 1000 &amp; 2000. The product is to be cleaned with hot water or a mild soapy cleaning agent. Do not use chlorine based, corrosive or abrasive cleaners as it may result in the surface being damaged.</p> <p>The following cleaning agents have been tested by Pressalit and may be used, as long as they are diluted according to the instructions on the container.</p> <p>DISINFECTANTS: Clinimax Difficil-S Erisan OXY+</p> <p>NON-DISINFECTANTS: Suma Star free D1 Taski 100 Taski 200</p> <p>The product must be wiped down with a soft rag wrung out in clear water immediately after cleaning, as some materials may otherwise be discolored and stained, and the surface coating may deteriorate.</p>
<b>Declaration of conformity</b>	<p>This product complies with the requirements of Council Directive 93/42/EEC concerning medical devices, as last amended by Council Directive 2007/47/EC of 5 September 2007. It also complies with all relevant requirements in the Council Directive 2006/42/EC (of 17 May 2006) on machinery and the Council Directive 2011/65/EC on RoHS.</p>



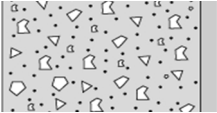

Product	Nursing bench 1000, electrically height adjustable
---------	--

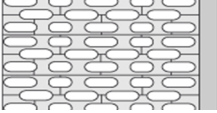
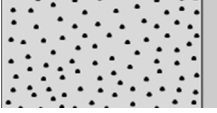
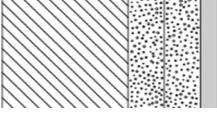
## Installation in different wall types

	<p><b>Concrete &gt;B25</b></p> <p>V8608 - Fixing kit, 6 coach screws Ø10 x 70 - plugs SX12. To be ordered separately.</p>
	<p><b>Solid Brick &gt;= Mz12</b></p> <p>V8608 - Fixing kit, 6 coach screws Ø10 x 70 - plugs SX12. To be ordered separately.</p>
	<p><b>Solid Sand Lime Brick &gt;= Hlz12</b></p> <p>V8608 - Fixing kit, 6 coach screws Ø10 x 70 - plugs SX12. To be ordered separately.</p>
	<p><b>Aerated Concrete P4</b></p> <p>V8658 - Fixing kit, 6 coach screws Ø10 x 70 - plugs GB14. To be ordered separately.</p>
	<p><b>Drywall (2 x 12,5 mm) water-resistant, re-enforced with wood</b></p> <p>V8608 - Fixing kit, 6 coach screws Ø10 x 70 - plugs SX12. NB! Plugs are not needed. To be ordered separately.</p>

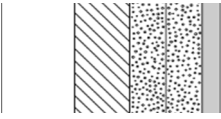

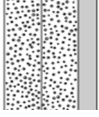
<p><b>Product</b></p>	<p>Nursing bench 1000, electrically height adjustable</p>
	<p><b>Drywall (2 x 12,5 mm) water-resistant, re-enforced with 22 mm plywood</b></p> <p>Wall fasteners (6 pcs) must be bought separately, for drywall it is possible to use e.g. fischer KD8 toggles or similar.</p>
	<p><b>Drywall (2 x 12,5 mm) water-resistant, re-enforced with steel plates (2 mm)</b></p> <p>Wall fasteners (6 pcs) must be bought separately, for drywall it is possible to use e.g. fischer KD8 toggles or similar.</p>
	<p><b>Drywall (2 x 12,5 mm) water-resistant</b></p> <p>Mounting in this wall type is not recommended - risk of fatal injury to persons and walls.</p>

It is the responsibility of the installer to ensure that suitable wall fasteners are used.

